

Diamond

TUB & SHOWERS

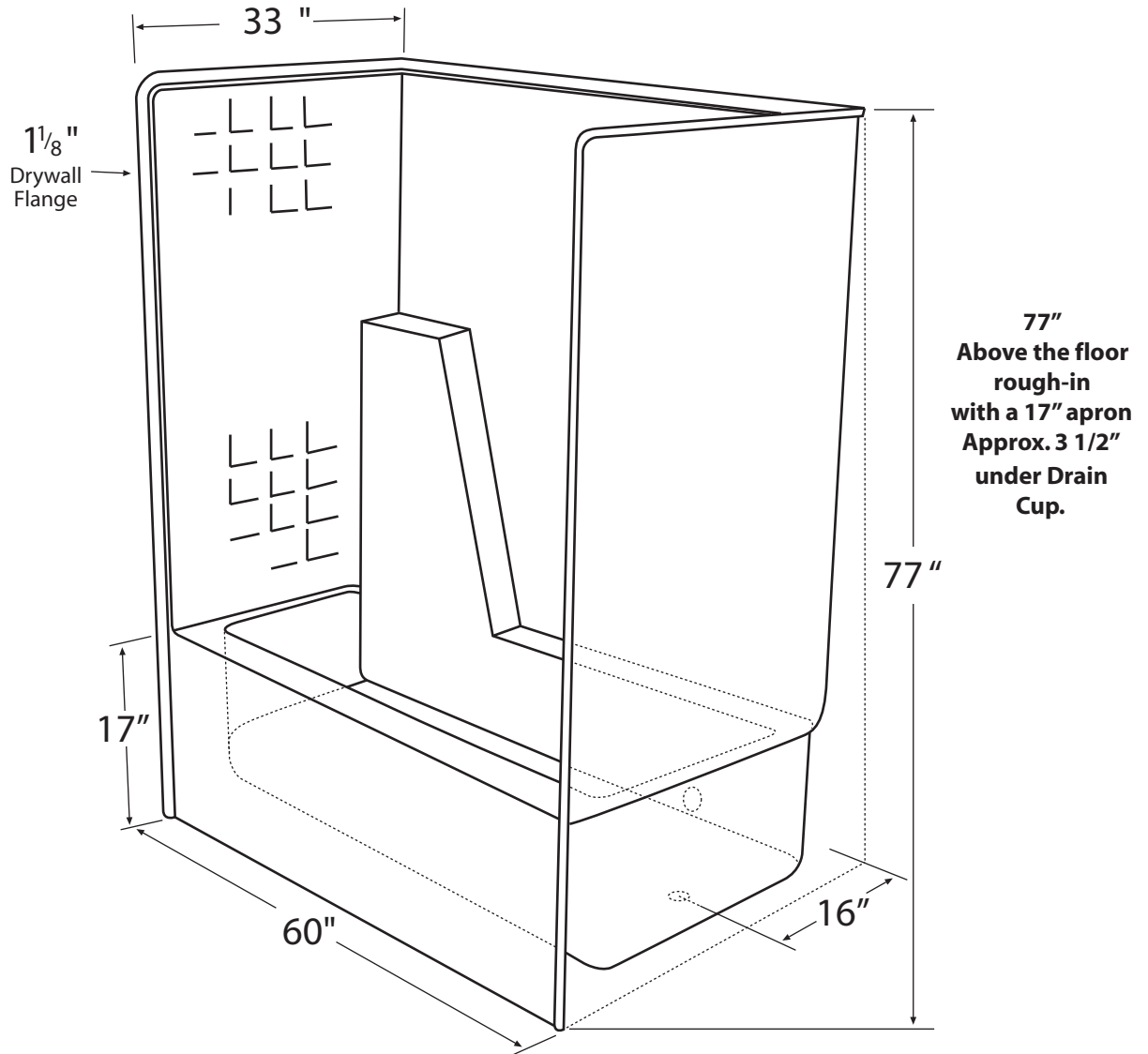

Information

Door Size:
56-5/8"w x 58 1/2"
Sump Sizes:
46" x 20" at bottom
51"w x 22" at C/L of overflow
11" from bottom of sump to C/L of overflow
Drain:
2 1/8" I.D. drain hole
16" to C/L from back wall
7 1/2" to C/L from side wall
2 1/2" I.D. overflow hole
Tolerances:
+0 -1/4"

Certified to confo
HUD/UM73b, ANSI
Z124.1, and ASTM
E-162 Flame Spread
Rating 200 or less and
is under a program of
factory inspection.

Tub & Shower Tile Builder--
One Piece
Model TTB 603377 R/L

Manufactured by
Front Line Mfg., Inc.
Leesburg, IN



5/4/06