

Diamond

TUB & SHOWERS

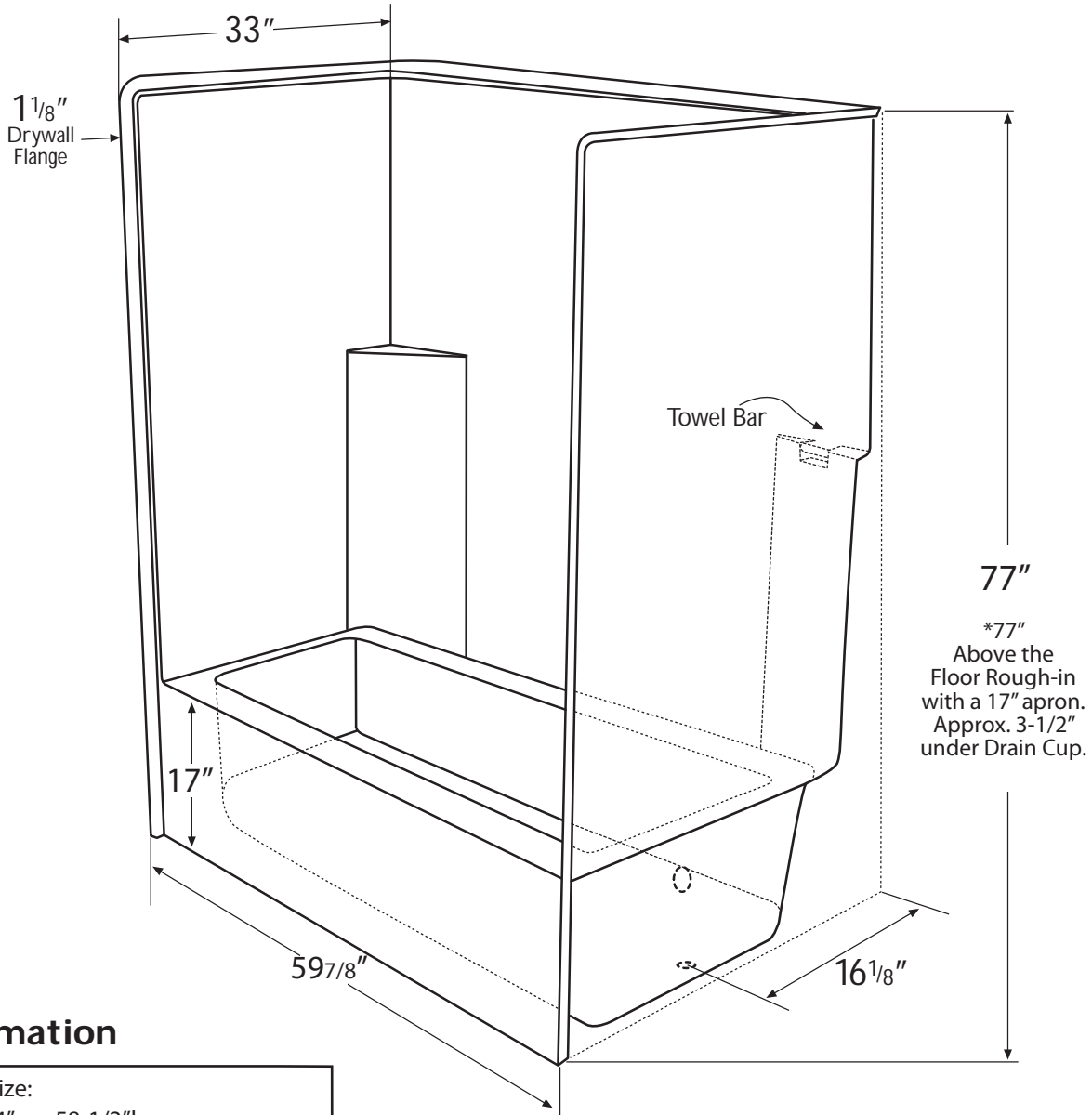

Information

Door Size:

55-1/4" w x 58-1/2" h

Sump Sizes:

44" x 19" at bottom,

50" x 22" at C/L of overflow

11-1/4" from floor to C/L of overflow

Drain:

16-1/8" from back wall to C/L of drain

10" C/L from side wall

2-1/8" I.D. drain hole

2-1/2" I.D. overflow hole

Tolerances:

+0, -1/4"

Certified to conform to HUD/UM73b, ANSI Z124.1, and ASTM E-162 Flame Spread Rating 200 or less and is under a program of factory inspection.

Tub & Shower Builder — One Piece Model TB 603377 R/L

*Model TB 603375 R/L

Manufactured by
Front Line Mfg., Inc.
Leesburg, IN

